



EN Operating instructions.pages 1 to 8
Original

Content

1 About this document

1.1 Function 1

1.2 Target group: authorised qualified personnel. 1

1.3 Explanation of the symbols used 1

1.4 Appropriate use 1

1.5 General safety instructions 1

1.6 Warning about misuse 1

1.7 Exclusion of liability 2

2 Product description

2.1 Ordering code 2

2.2 Special versions. 2

2.3 Purpose 2

2.4 Technical data 3

2.5 Safety classification of the interlocking function. 3

2.6 Safety classification of the guard locking function 3

3 Mounting

3.1 General mounting instructions 4

3.2 Dimensions 4

3.3 Mounting of the actuator 4

4 Electrical connection

4.1 General information for electrical connection. 5

4.2 Contact variants. 5

5 Set-up and maintenance

5.1 Functional testing. 6

5.2 Maintenance 6

6 Disassembly and disposal

6.1 Disassembly. 6

6.2 Disposal 6

7 EU Declaration of conformity

1. About this document

1.1 Function

This operating instructions manual provides all the information you need for the mounting, set-up and commissioning to ensure the safe operation and disassembly of the safety switchgear. The operating instructions must be available in a legible condition and a complete version in the vicinity of the device.

1.2 Target group: authorised qualified personnel

All operations described in this operating instructions manual must be carried out by trained specialist personnel, authorised by the plant operator only.

Please make sure that you have read and understood these operating instructions and that you know all applicable legislations regarding occupational safety and accident prevention prior to installation and putting the component into operation.

The machine builder must carefully select the harmonised standards to be complied with as well as other technical specifications for the selection, mounting and integration of the components.

1.3 Explanation of the symbols used



Information, hint, note:

This symbol is used for identifying useful additional information.



Caution: Failure to comply with this warning notice could lead to failures or malfunctions.

Warning: Failure to comply with this warning notice could lead to physical injury and/or damage to the machine.

1.4 Appropriate use

The products described in these operating instructions are developed to execute safety-related functions as part of an entire plant or machine. It is the responsibility of the manufacturer of a machine or plant to ensure the correct functionality of the entire machine or plant.

The safety switchgear must be exclusively used in accordance with the versions listed below or for the applications authorised by the manufacturer. Detailed information regarding the range of applications can be found in the chapter "Product description".

1.5 General safety instructions

The user must observe the safety instructions in this operating instructions manual, the country specific installation standards as well as all prevailing safety regulations and accident prevention rules.



Further technical information can be found in the Schmersal catalogues or in the online catalogue on the Internet: www.schmersal.net.

The information contained in this operating instructions manual is provided without liability and is subject to technical modifications.

There are no residual risks, provided that the safety instructions as well as the instructions regarding mounting, commissioning, operation and maintenance are observed.

1.6 Warning about misuse



In case of improper use or manipulation of the safety switchgear, personal hazards or damages to machinery or plant components cannot be excluded. The relevant requirements of the standard ISO 14119 must be observed.

1.7 Exclusion of liability

We shall accept no liability for damages and malfunctions resulting from defective mounting or failure to comply with this operating instructions manual. The manufacturer shall accept no liability for damages resulting from the use of unauthorised spare parts or accessories.

For safety reasons, invasive work on the device as well as arbitrary repairs, conversions and modifications to the device are strictly forbidden; the manufacturer shall accept no liability for damages resulting from such invasive work, arbitrary repairs, conversions and/or modifications to the device.

2. Product description

2.1 Ordering code

This operating instructions manual applies to the following types:

AZM 161 ①-②③④⑤⑥-⑦⑧-⑨

No.	Option	Description
①	CC	Cage clamps
	SK	Screw terminals
	ST	M12 x 1 connector
②	11 / 03	1 NO / 4 NC contact with connector
	11 / 12	2 NO / 3 NC contact with connector
	12 / 03	1 NO / 5 NC
	12 / 11	2 NO / 3 NC contact with connector
	12 / 12	2 NO / 4 NC
③	R	Latching force 5 N
		Latching force 30 N
④	A	Power to lock
⑤		Power to unlock
	ED	Manual release on the cover side
	EU	Manual release on the rear side
⑥	T	Lateral emergency exit
	TD	Emergency exit on the cover side
	TU	Emergency exit on the rear side
	N	Emergency release
	⑦	024
⑧	110/230	U _s 110/230 VAC
	G	without LED
⑨	B1	With LED (24 V only)
	B1E	Actuator B1 included
	B6L	Actuator B1E included
	B6R	Actuator B6 left included
	B1-1747	Actuator B6 right included
	B1-2024	Actuator B1-1747 included
	B1-2053	Actuator B1-2024 included
B1-2177	Actuator B1-2053 included	
	B1-2177	Actuator B1-2177 included



Only if the information described in this operating instructions manual are realised correctly, the safety function and therefore the compliance with the Machinery Directive is maintained.

2.2 Special versions

For special versions, which are not listed in the order code below 2.1, these specifications apply accordingly, provided that they correspond to the standard version.

2.3 Purpose

The solenoid interlock has been designed to prevent in conjunction with the control part of a machine, movable safety guards from being opened before hazardous conditions have been eliminated. The AZM 161 I solenoid interlocks with individual coding offer a higher protection against tampering.



The safety switchgear units are classified as type 2 interlocking devices in accordance with ISO 14119 and are rated as highly coded.



Interlocks with power to lock principle may only be used in special cases after a thorough evaluation of the accident risk, since the safety guard can be opened immediately on failure of the power supply or upon activation of the main switch.

Manual release

(for set-up, maintenance, etc.)

The manual release is realised by turning the triangular key, so that the locking bolt is pulled into the unlocking position. The normal locking function is only restored after the triangular key has been returned to its original position. After being put into operation, the manual release must be secured by installing the plastic cover, which is included in delivery.

Lateral manual release

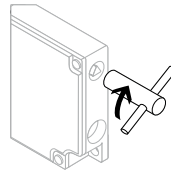

Manual release on the cover side or on the rear side (ordering suffix -ED/-EU)

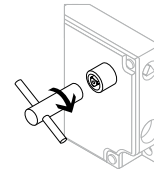

Triangular key TK-M5 (101100887) available as accessory.

Emergency release (ordering suffix -N)

(mounting only on the outside of the safety guard)



The emergency release should only be used in an emergency. The solenoid interlock should be installed and/or protected so that an inadvertent opening of the interlock by an emergency release can be prevented. The emergency release must be clearly labelled that it should only be used in an emergency. The label can be used that was included in the delivery.

To activate the emergency release in case of an emergency, the orange lever must be turned to the stop in the direction marked by the arrow. In this position, the safety guard can be opened. The lever is latched and cannot be returned to its original position. To cancel the blocking condition, the central mounting screw must be loosened to such extent that the lever can be turned back into its original position. The screw must then be re-tightened.

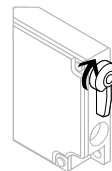

Emergency exit

(Fitting and actuation only from within the hazardous area)

To activate the emergency exit of the T version in case of an emergency, the orange lever must be turned to the stop in direction marked by the arrow. The emergency exit function of the TD and TU versions is activated by pressing the red pushbutton.

In this position, the safety guard can be opened. The blocking condition is cancelled by turning the lever in opposite direction or by pulling back the pushbutton. In unlocked position, the safety guard is protected against unintentional closing.

Lateral emergency exit (ordering suffix -T)

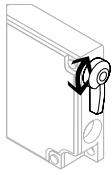

Emergency exit on the cover side or on the rear side (ordering suffix -TD/-TU)

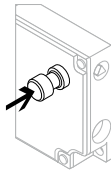

The user must evaluate and design the safety chain in accordance with the relevant standards and the required safety level.



The entire concept of the control system, in which the safety component is integrated, must be validated to the relevant standards.

2.4 Technical data

Standards:	IEC 60947-5-1, ISO 14119
Enclosure:	glass-fibre reinforced thermoplastic, self-extinguishing
Actuator and locking bolt:	stainless steel 1.4301
Holding force:	
- F_{Zh} :	2,000 N
- F_{max} :	2,600 N
Latching force:	30 N for ordering suffix R
Coding level according to ISO 14119:	high
Protection class:	IP67
Contact material:	Silver
Contact type:	Change-over contact with double break type Zb, with galvanically separated contact bridges
Switching system:	A acc. IEC 60947-5-1 slow action, NC contact with positive break
Connection:	screw terminals or cage clamps or connector
Cable type:	flexible
Cable section:	min. 0.25 mm ² , max. 1.5 mm ² (including conductor ferrules)
Cable entry:	4 x M16 x 1.5
Positive break travel (unlocked):	10 mm
Positive break force (unlocked):	10 N for each NC contact fitted
Actuating speed:	max. 2 m/s
Actuating frequency:	max. 1,000 operations/h
Mechanical life:	> 1.000.000 operations
Ambient temperature:	-25 °C ... +60 °C

Electrical data:

Utilisation category:	AC-15, DC-13
Rated operating current / voltage I_n/U_n :	4 A / 230 VAC 2.5 A / 24 VDC
- ST 4-pole:	4 A / 230 VAC 4 A / 24 VDC
- ST 8-pole:	2 A / 24 VDC
Rated impulse withstand voltage U_{imp} :	4 kV
- Connector ST 4-pole:	2.5 kV
- Connector ST 8-pole:	0.8 kV
Rated insulation voltage U_i :	250 V
- Connector ST 4-pole:	250 V
- Connector ST 8-pole:	60 V
Thermal test current I_{the} :	6 A
- Connector 4-pole:	4 A
- Connector 8-pole:	2 A
Max. fuse rating:	6 A gG D-fuse
- Connector 4-pole:	4 A gG D-fuse
- Connector 8-pole:	2 A gG D-fuse
Required rated short-circuit current:	1,000 A
Rated control voltage U_s :	24 VDC
	24 VAC / 50/60 Hz 110 VAC / 50/60 Hz 230 VAC / 50/60 Hz

Electrical data – Magnet control:

Magnet switch-on time:	100 %
Power consumption:	max. 10 W
Accepted test pulse duration on input signal:	≤ 5.0 ms
- With test pulse interval of:	≥ 50 ms



Use Type 4X (Indoor Use) and 12 connector fittings.
Tightening torque rating: 4.4 lb in.

2.5 Safety classification of the interlocking function

Standards: ISO 13849-1

Envisaged structure:

- Basically: applicable up to Cat. 1 / PL c
- With 2-channel usage and fault exclusion mechanism*: applicable up to Cat. 3 / PL d with suitable logic unit

B_{10D} NC contact: 2,000,000

B_{10D} NO contact at 10% ohmic contact load: 1,000,000

Mission time: 20 years

* If a fault exclusion to the 1-channel mechanics is authorised.

$$MTTF_D = \frac{B_{10D}}{0,1 \times n_{op}} \quad n_{op} = \frac{d_{op} \times h_{op} \times 3600 \text{ s/h}}{t_{cycle}}$$

(Determined values can vary depending on the application-specific parameters h_{op} , d_{op} and t_{cycle} as well as the load.)

If multiple safety components are wired in series, the Performance Level to ISO 13849-1 will be reduced due to the restricted error detection under certain circumstances.

2.6 Safety classification of the guard locking function

If the device is used as an interlock for personal safety, a safety classification of the guard locking function is required.

When classifying the interlock function, a distinction must be made between monitoring of the interlock function (locking function) and controlling the unlocking function.

The following safety classification of the unlocking function is based on the application of the principle of safety energy disconnection for the solenoid supply.



The classification of the release function is only valid for devices with monitored guard locking function and in the power to unlock version (see ordering code).

A fault exclusion for the locking device of the solenoid interlock can be assumed by a safety external energy disconnection.

In this case, the locking device of the solenoid interlock does not have an effect on the failure probability of the unlock function.

The safety level of the unlock function is determined exclusively by the external safety power shutdown.

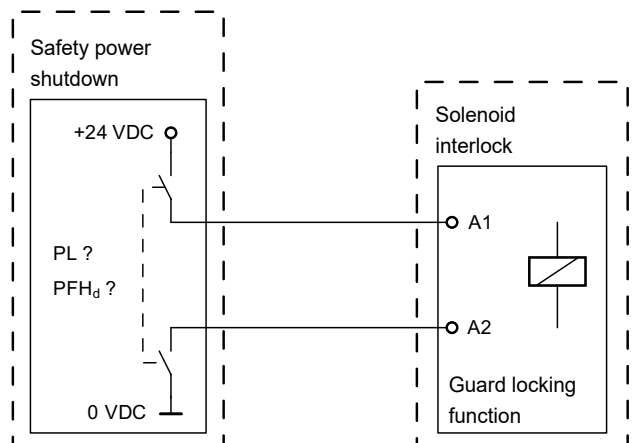



Fault exclusion with regard to wiring routing must be observed.



If for a certain application the power to unlock version of a solenoid interlock cannot be used, for this exception an interlock with power to lock can be used if additional safety measure need to be realised that have an equivalent safety level.

3. Mounting

3.1 General mounting instructions



On delivery, the actuator is in inserted condition. For power-to-unlock components, the actuator must be released by means of the manual release. On delivery, the actuator is in inserted condition. For power-to-unlock components, the actuator must be released by means of the manual release. If the triangular key is turned 180°, the locking bolt is pulled into the unlocking position. The normal locking function is only restored after the triangular key has been returned to its original position.

Three mounting holes are provided for fixing the enclosure. The solenoid interlock is double insulated. The use of an earth wire is not authorised. The solenoid interlock must not be used as an end stop. Any mounting position. The mounting position however must be chosen so that the ingress of dirt and soiling in the used opening is avoided. Unused actuator openings must be sealed with slot sealing plugs.



The actuator must be permanently fitted to the safety guards and protected against displacement by suitable measures (tamperproof screws, gluing, drilling of the screw heads).



Please observe the relevant requirements of the standards ISO 12100, ISO 14119 and ISO 14120.

3.2 Dimensions

All measurements in mm.

Solenoid interlock AZM 161

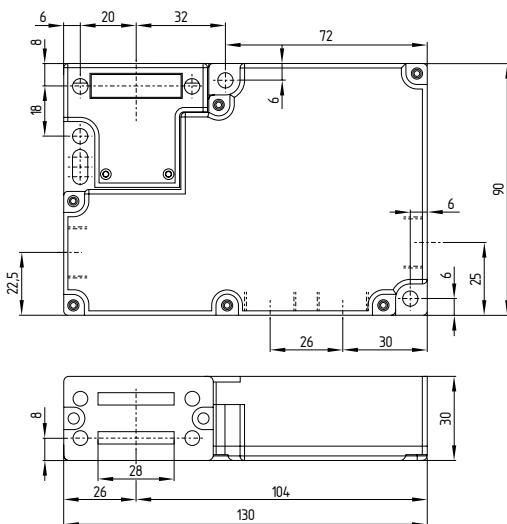

Actuator

Straight actuator B1

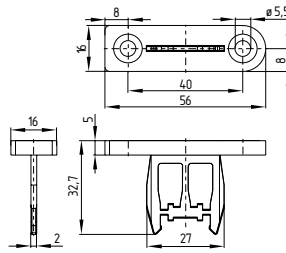

Straight actuator B1E

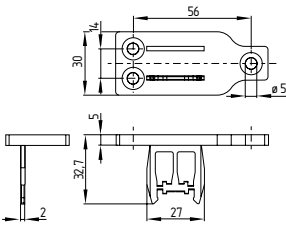

Flexible actuator B6L

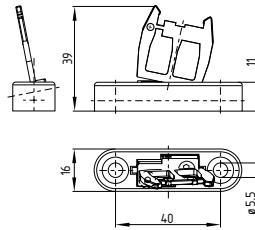

Actuator B1-2053 with ball latch

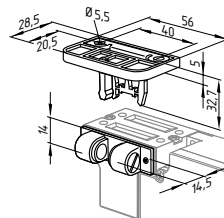

3.3 Mounting of the actuator



The marks on the used actuator opening of the solenoid interlock and on the actuator must be opposite.

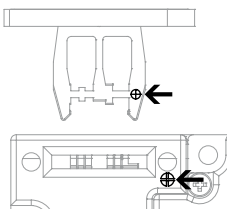

Use tamper-proof screws (available as accessory) to prevent unauthorised unscrewing. Please observe that, when fixing the switch e.g. by means of rivetting or welding, the insertion depth of the actuator is not modified. Different actuator models are available: for sliding and removable safety guards, preferably use the AZM 161-B1 and AZM 161-B1E actuator. For hinged guards, the AZM 161-B6L or AZM 161- B6R actuator.

When the switch is fitted on a hinged safety guard, please ensure that the point of rotation is located within the range of the upper surface of the safety switch, in which the actuator hook is inserted (refer to table).

B1-1747 Straight design with magnetic latch

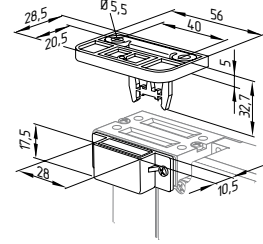

Actuator B1-2024 with slot lip-seal

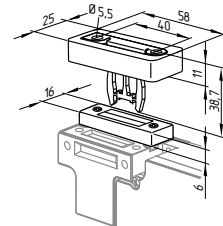

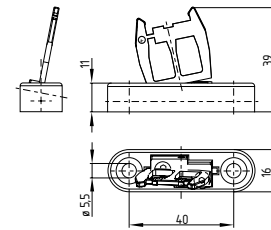

Flexible actuator B6R

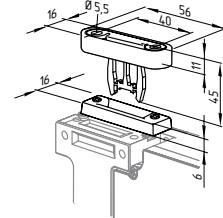

Actuator B1-2177 with centering guide

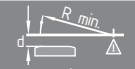

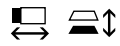
Actuating radii					
		R _{min} [mm]	d [mm]	R _{min} [mm]	d [mm]
	AZM 161-B6L	95	11	95	11
	AZM 161-B6R	95	11	95	11
	AZM 161 B1	-	-	-	-
	AZM 161 B1-1747	-	-	-	-
	AZM 161 B1-2024	-	-	-	-
	AZM 161 B1-2053	-	-	-	-
	AZM 161 B1-2177	-	-	-	-

Key

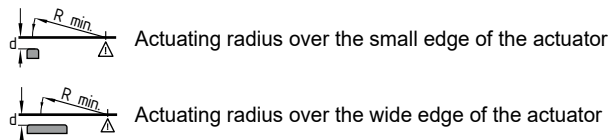

The axis of the hinge must be d mm above and in a parallel plane to the top surface of the safety switch. The basis setting provides a minimum radius of R_{min}.

Setting screw

The AZM 161-B6L or AZM 161-B6R actuator is set to the smallest radius in factory. To increase the radius, the setting screws a + b must be turned by means of a hexagonal key A/F 2.0 mm.

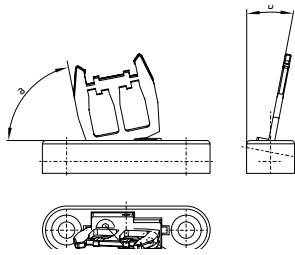

4. Electrical connection

4.1 General information for electrical connection



The electrical connection may only be carried out by authorised personnel in a de-energised condition.



If the risk analysis indicates the use of a monitored interlock they are to be connected in the safety circuit with the contacts indicated with the symbol .

Appropriate cable glands with a suitable degree of protection are to be used. Remove the walls of the mounting holes by inserting the cable entry.

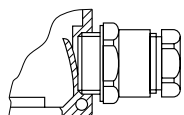

Puncturing the wall of the holes with auxiliary tools (e.g. screwdriver) can cause damage.



Information for the selection of suitable safety-monitoring modules can be found in the Schmersal catalogues or in the online catalogue on the Internet: www.schmersal.net.

4.2 Contact variants

Contacts are shown in the de-energised condition and with the actuator inserted.

Power to unlock

AZM 161SK-12/12...
AZM 161CC-12/12...

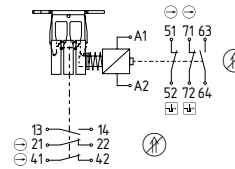

13 14 21 22 41 42 51 52 63 64 71 72 A1 A2

AZM 161SK-12/03...
AZM 161CC-12/03...

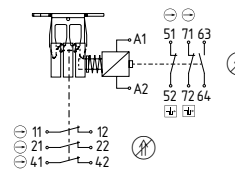

13 14 21 22 41 42 51 52 63 64 71 72 A1 A2

Power to lock

AZM 161SK-12/12...A...
AZM 161CC-12/12...A...

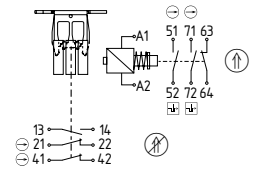

13 14 21 22 41 42 51 52 63 64 71 72 A1 A2

AZM 161SK-12/03...A...
AZM 161CC-12/03...A...

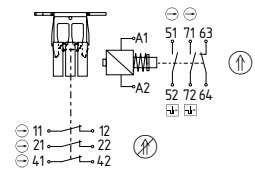

13 14 21 22 41 42 51 52 63 64 71 72 A1 A2

Key

- A Positive break NC contact
-  Monitoring the interlock according to ISO 14119
- P Actuated
- Q Not actuated

AZM 161ST-../.. with connector

AZM 161ST-12/11...

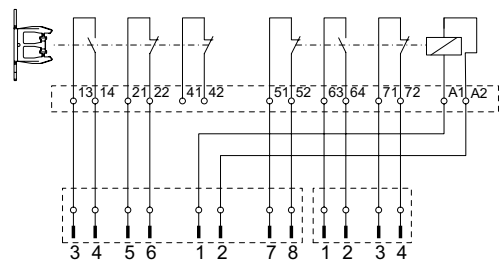

AZM 161ST-11/12...

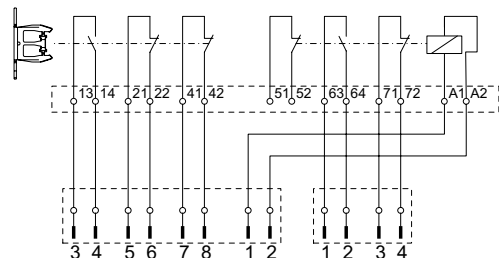

AZM 161ST-11/03...

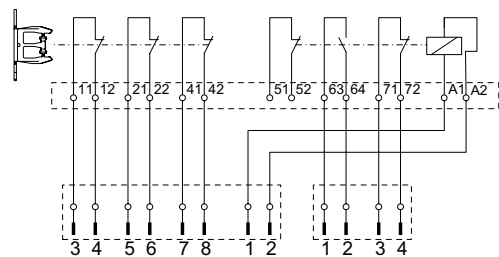

Integrated contact kit 12/12 G (with LED)

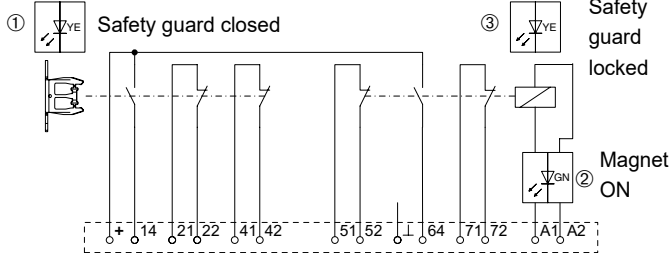

Integrated contact kit 12/03 G (with LED)



AZM 161...-024-G (with LED)

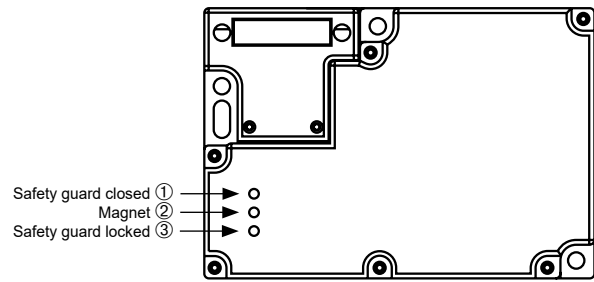

Power to unlock

System condition	Solenoid control Power to unlock	LED		
		yellow ①	green ②	yellow ③
Guard open	24 V	Off	On	Off
Door closed, actuator inserted, not locked	24 V	On	On	Off
Guard closed, actuator inserted and locked	0 V	On	Off	On

Power to lock

System condition	Solenoid control Power to lock	LED		
		yellow ①	green ②	yellow ③
Guard open	0 V	Off	Off	Off
Door closed, actuator inserted, not locked	0 V	On	Off	Off
Guard closed, actuator inserted and locked	24 V	On	On	On

5. Set-up and maintenance

5.1 Functional testing

The safety function of the safety components must be tested. The following conditions must be previously checked and met:

1. Fitting of the solenoid interlock and the actuator
2. Check the integrity of the cable entry and connections
3. Check the switch enclosure for damage

5.2 Maintenance

A regular visual inspection and functional test, including the following steps, is recommended:

1. Check for tight installation of the actuator and the switch
2. Remove particles of dust and soiling
3. Check cable entry and connections



Adequate measures must be taken to ensure protection against tampering either to prevent tampering of the safety guard, for instance by means of replacement actuators.

Damaged or defective components must be replaced.

6. Disassembly and disposal

6.1 Disassembly

The safety switchgear must be disassembled in a de-energised condition only.

6.2 Disposal

The safety switchgear must be disposed of in an appropriate manner in accordance with the national prescriptions and legislations.

7. EU Declaration of conformity

EU Declaration of conformity



Original
K.A. Schmersal GmbH & Co. KG
Möddinghofe 30
42279 Wuppertal
Germany
Internet: www.schmersal.com

We hereby certify that the hereafter described components both in their basic design and construction conform to the applicable European Directives.

Name of the component: AZM 161 I

Type: See ordering code

Description of the component: Interlocking device with electromagnetic interlock for safety functions

Relevant Directives:
Machinery Directive 2006/42/EC
EMC-Directive 2014/30/EU
RoHS-Directive 2011/65/EU

Applied standards: DIN EN 60947-5-1:2010,
DIN EN ISO 14119:2014

Person authorised for the compilation of the technical documentation: Oliver Wacker
Möddinghofe 30
42279 Wuppertal

Place and date of issue: Wuppertal, November 7, 2017

Authorised signature
Philip Schmersal
Managing Director

AZM161I-D-EN



The currently valid declaration of conformity can be downloaded from the internet at www.schmersal.net.



K.A. Schmersal GmbH & Co. KG
Möddinghofe 30, 42279 Wuppertal
Germany
Phone: +49 202 6474-0
Telefax: +49 202 6474-100
E-Mail: info@schmersal.com
Internet: www.schmersal.com